



# VARIE MISCELLANEOUS

MOLLE A GAS .....	353
<i>GAS SPRINGS</i>	
ADESIVI E TARGHE.....	358
<i>STICKERS AND PANELS</i>	
NASTRI ANTISDRUCCIOLO.....	359
<i>ANTI-SLIP TAPES</i>	
FASCETTE IN PLASTICA .....	360
<i>PLASTIC TIES</i>	
MANIGLIE E CERNIERE.....	360
<i>HANDLES AND HINGES</i>	
CHIUSURE COFANO.....	361
<i>LOCKS FOR BONNETS</i>	
SPECCHI RETROVISORI.....	362
<i>REAR-VIEW MIRRORS</i>	
TRANSPALLET MANUALI.....	364
<i>MANUAL TRANSPALLET</i>	
PEDANA BLOCCAGGIO TRANSPALLET.....	364
<i>TRANSPALLET STOPPER</i>	
SOLLEVATORI .....	364
<i>JACKS</i>	
TERGICRISTALLO.....	365
<i>WINDSHIELD WIPERS</i>	
INGRASSATORI.....	366
<i>GREASE NIPPLES</i>	
SPAZZOLE CARRELLI PER PULIZIA PIAZZALI .....	370
<i>CLEANING BRUSHES FOR FORKLIFTS</i>	



# MOLLE A GAS GAS SPRINGS

Molle a gas universali.  
Applicazioni: cofani, portiere,  
timoni di comando, etc.

Universal gas springs.  
Applications: bonnets, doors,  
steering levers, etc.

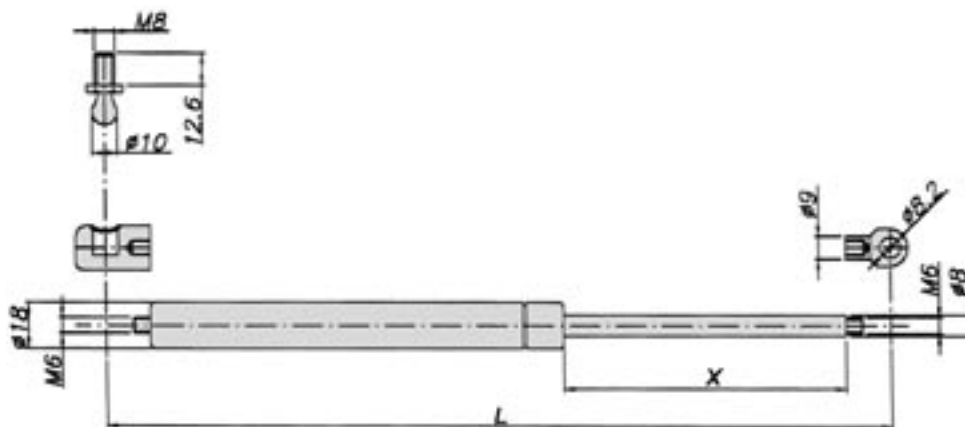

Art. Part no.	Lungh. L Length	X Corsa Run	Forza Force
23020N15	200	62	150N
23020N20			200N
23020N35			350N
23025N20	250	82	200N
23025N35			350N
23030N20	300	112	200N
23030N35			350N
23035N20	350	142	200N
23035N35			350N
23040N20	400	172	200N
23040N35			350N
23045N20	450	192	200N
23045N35			350N
23050N20	500	212	200N
23050N35			350N
23055N20	550	232	200N
23055N35			350N
23060N20	600	262	200N
23060N35			350N
23065N20	650	282	200N
23065N35			350N
23070N20	700	312	200N
23070N35			350N



Altri tipi di molla sono disponibili su richiesta.  
Other gas spring types are available upon request.

Art. Part no.	Descrizione Description	Figura Fig.
23001	Attacco in plastica / Plastic clamp	A
23001M	Attacco in metallo / Metal clamp	D
23002	Perno a sfera / Ball stud	B
23003	Occhiello / Hole joint	C

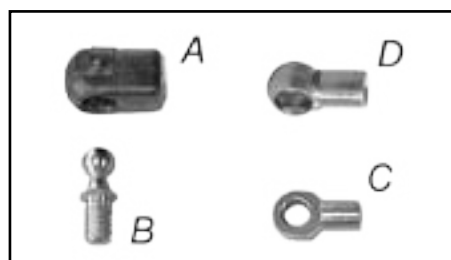



23139



23141



23116



23140



23105



23138



23126



23113



23119



23123



23124



23127

Art. Part no.	L <sub>tot</sub>	Forza Force	Ø Stelo Ø Rod	Note Notes	Adattabile Application
23139	118		8	n°2 x M12	JUNGHEINRICH
23141	186	150	6	n°2 x Ø6	JUNGHEINRICH
23116	198	100N	8	n°2 x Ø10	JUNGHEINRICH
23140	199	440N	10	Ø8 + Ø10	JUNGHEINRICH
23105	205	600N	8	n°2 x M8	BT TOYOTA
23138	223	450N	10	Ø8 + Ø10	JUNGHEINRICH
23126	225	200N	8	n°2 x Ø8	ICEM
23113	235	300N	8	D.19 + M8	
23119	235	500N	10	Ø8 + M8(8)	STILL LINDE PIMESPO KOMATSU
23123	236	170N	8	D.19 + Ø8	
23124	236	220N	8	D.19 + Ø8	
23127	255	300N	8	n°2 x Ø8	ICEM



23117



23115



23128



23109



70115



70027



23114



23137



23107



23122



23121



23101

Art. Part no.	L <sub>tot</sub>	Forza Force	Ø Stelo Ø Rod	Note Notes	Adattabile Application
23117	258	460N	10	M8 + M8(8)	PIMESPO KOMATSU STILL
23115	270	800N	10	n°2 x M8	JUNGHEINRICH
23128	275	380N	6	n°2 x M8	ICEM
23109	280	350N	8	D.19 + M8(8)	
70115	280		8	n°2 x M8	LUGLI
70027	285		8	n°2 x Ø8	LUGLI
23114	290	300N	8	D.19 + Ø8	
23137	298	550N	8	n°2 x M8	JUNGHEINRICH
23107	300	350N	8	Ø8 + M8(28)	
23122	310	250N	8	n°2 x M8	LINDE
23121	315	250N	6	n°2 x M8	LINDE
23101	320	710N	8	Ø8 + M8(24)	OMG



23106



23129



23102



23108



23120



23118



70117



70321



23110



70320



23100



23130

Art. Part no.	L <sub>tot</sub>	Forza Force	Ø Stelo Ø Rod	Note Notes	Adattabile Application
23106	320	900N	10	Ø8 + M8(18)	
23129	325	350N	8	n°2 x M8	STILL
23102	325	460N	10	n°2 x Ø8	STILL
23108	330	350N	8	Ø8 + M8(28)	
23120	330	550N	10	Ø8 + Ø16(ball)	JUNGHEINRICH
23118	330	700N	8	D.19 + M8	PIMESPO KOMATSU
70117	350		10	n°2 x Ø8	LUGLI
70321	350		10	n°2 x M10	LUGLI
23110	360	350N	8	n°2 x Ø8	
70320	375		10	n°2 x M10	LUGLI
23100	400	280N	8	n°2 x M8	LINDE portiera cabina / cabin door
23130	400	600N	8	n°2 x Ø8	STILL



23133



23132



23134



70325



23104



70324



23136



23111



23103



23112







23135



70323

Art. Part no.	L <sub>tot</sub>	Forza Force	Ø Stelo Ø Rod	Note Notes	Adattabile Application
23133	400	800N	8	n°2 x Ø8	HYSTER
23132	405	2100N	14	n°2 x Ø10	CESAB
23134	410	1200N	10	Ø8 + M8	CESAB
70325	443		8	D.19 + Ø8	LUGLI
23104	465	500N	8	Ø8 + M8(32)	DECA
70324	465		10	n°2 x M10	LUGLI
23136	490	365N	10	Ø8 + Ø16(ball)	JUNGHEINRICH
23111	545	300N	8	n°2 x Ø8	
23103	630	310N	10	n°2 x Ø8	STILL
23135	685	500N	8	n°2 x Ø8	CESAB
70323	760		10	Ø8 + M10(8)	LUGLI

# ADESIVI E TARGHE STICKERS AND PANELS

<p><b>28000</b> <b>28001</b> <b>28002</b> <b>28003</b> <b>28004</b> <b>28005</b> <b>28006</b> <b>28007</b> <b>28008</b> <b>28009</b> <b>28010</b> <b>28011</b> <b>28012</b> <b>28015</b> <b>28020</b></p>	<p>Serie adesivi universali per carrelli elevatori. <i>Universal sticker sets for forklift bodywork.</i> Per / For: CATERPILLAR Per / For: CESAB Per / For: DETAS Per / For: CLARK Per / For: HYSTER Per / For: LINDE Per / For: LUGLI Per / For: NICHYU Per / For: NISSAN Per / For: PIMESPO Per / For: SIBICAR-BALKANCAR Per / For: STILL Per / For: TOYOTA Per / For: JUNGHEINRICH Per / For: YALE</p>	
<p><b>28013</b> <b>28014</b></p>	<p>Adesivi con marchio OM. Sticker brand OM.</p> <p>206 x 148 mm 116 x 82 mm</p>	
<p><b>28019</b> <b>28016</b>  <b>28017</b> <b>28018</b></p>	<p>Adesivi per modelli STILL. Sticker for STILL models.</p> <p>Per / For: STILL RX20-16 Per / For: STILL RX20-20</p> <p>Per / For: STILL RX60-25 Per / For: STILL RX60-30</p>	
<p><b>9224</b></p>	<p>Serie adesivi anti-infortunistica universali. <i>Universal safety stickers (Italian only).</i></p>	
<p><b>9224P</b></p>	<p>Serie adesivi anti-infortunistica universali. Serie estesa. <i>Universal safety stickers (Italian only). Extended set.</i></p>	

12

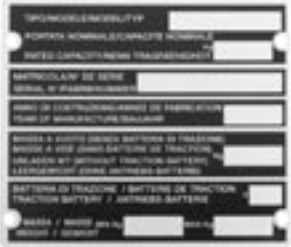
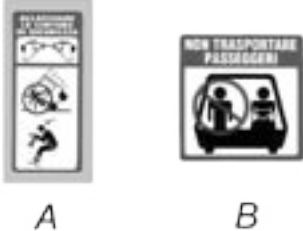
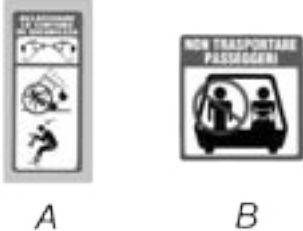

<p><b>9232</b></p>	<p>Targa metallica per identificazione carrello elevatore.  <i>Metal identification plate (Italian only).</i>          Dim.: 150x150</p>	
<p><b>9232P</b></p>	<p>Targa metallica piccola per identificazione carrello elevatore.  <i>Small metal identification plate (Italian only).</i>          Dim.: 90x78</p>	
<p><b>9218G</b></p>	<p>Adesivo per cinture di sicurezza.  <i>Sticker for seat belts (Italian only).</i>          (Fig. A)</p>	
<p><b>9218H</b></p>	<p>Adesivo divieto passeggeri.  <i>Sticker "no passengers" (Italian only).</i>          (Fig. B)</p>	

## NASTRI ANTISDRUCCIOLO ANTI-SLIP TAPES

<p><b>9921</b></p>	<p>Rotolo antisdrucchio autoadesivo <b>3M</b>, larghezza 25 mm, lunghezza 18,3 metri.  <b>3M anti-slip adhesive tape, 25 mm wide, 18,3 meter long.</b></p>	
<p><b>9922</b>  <b>9922A</b></p>	<p>Rotolo antisdrucchio autoadesivo <b>3M</b>, larghezza 300 mm, lunghezza 18,3 metri.  <b>3M anti-slip adhesive tape, 300 mm wide, 18,3 meter long.</b></p> <p>Striscia 300 x 250 mm.  <b>300 x 250 mm sheet.</b></p>	



## FASCETTE IN PLASTICA PLASTIC TIES

	Fascette in nylon. Confezione da 100 pezzi. <i>Nylon cable ties. 100-piece package.</i>	
<b>9160C</b>	<b>BIANCHE / WHITE</b> 100 x 2.5, Ø max 24	
<b>9161C</b>	140 x 3.5, Ø max 36	
<b>9162C</b>	160 x 4.5, Ø max 40	
<b>9163C</b>	200 x 4.5, Ø max 51	
<b>9164C</b>	280 x 4.5, Ø max 76	
<b>9165C</b>	360 x 4.5, Ø max 101	
<b>9166C</b>	360 x 7.5, Ø max 101	
<b>9167C</b>	450 x 7.5, Ø max 130	
<b>9160NC</b>	<b>NERE / BLACK</b> 100 x 2.5, Ø max 24	
<b>9161NC</b>	140 x 3.5, Ø max 36	
<b>9162NC</b>	160 x 4.5, Ø max 40	
<b>9163NC</b>	200 x 4.5, Ø max 51	
<b>9164NC</b>	280 x 4.5, Ø max 76	
<b>9165NC</b>	360 x 4.5, Ø max 101	
<b>9166NC</b>	360 x 7.5, Ø max 101	

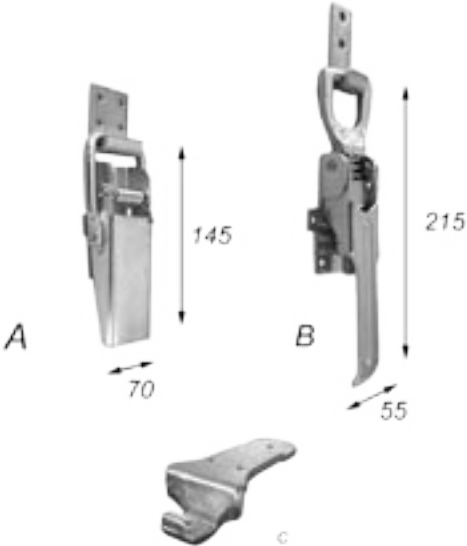

## MANIGLIE E CERNIERE HANDLES AND HINGES

<b>9285B</b>	Maniglia universale in materiale plastico. <i>Universal plastic handle.</i>	
<b>9285C</b>	Maniglia in metallo e rivestimento in plastica. <i>Metal handle with plastic grip.</i>  Adatt. / Applic.: LUGLI	
<b>70101</b>	Cerniera cofano. <i>Bonnet hinge.</i>  Adatt. / Applic.: LUGLI	

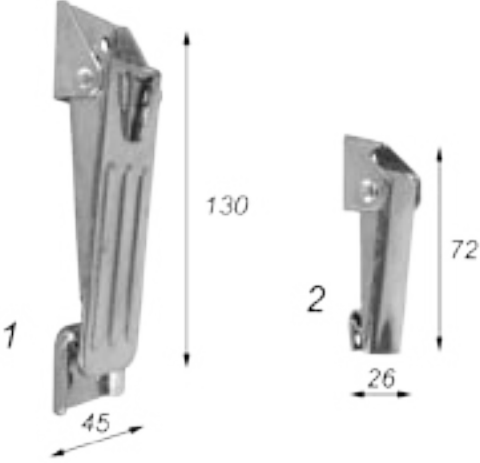
# CHIUSURE COFANO LOCKS FOR BONNETS

<p><b>9280</b></p> <p>Fissa / <i>Fixed.</i> (Fig. A) Carico di rottura / <i>Tensile strength:</i> 10000N</p> <p><b>9281</b></p> <p>Registrabile / <i>Adjustable.</i> (Fig. B) Carico di rottura / <i>Tensile strength:</i> 4000N</p> <p><b>9281RI</b></p> <p>Riscontro ad angolo / <i>Edge hook</i> Per / for: 9281 (Fig. C)</p>	<p>Chiusure con riscontro dritto, in acciaio zincato. <i>Steel locks for bonnets with straight hook.</i></p>	
<p><b>9284</b></p>	<p>Chiusura universale regolabile in acciaio zincato, con riscontro. <i>Universal steel lock with hook.</i> Carico di rottura / <i>Tensile strength:</i> 2500N</p>	
<p><b>9282</b></p>	<p>Chiusura registrabile, con fermo e riscontro, in acciaio verniciato. <i>Adjustable locks for bonnets, with stop and hook, painted steel.</i></p> <p>Adattabile / <i>Application:</i> OM</p>	
<p><b>9283</b></p> <p>Grande / <i>Large size</i> (Fig. 1) Carico di rottura / <i>Tensile strength:</i> 4000N Adattabile / <i>Application:</i> LUGLI CESAB</p> <p><b>9283A</b></p> <p>Piccolo / <i>Small size</i> (Fig. 2) Carico di rottura / <i>Tensile strength:</i> 1400N Adattabile / <i>Application:</i> LUGLI</p>	<p>Chiusure in acciaio zincato regolabili, con riscontro. <i>Adjustable steel locks, with hook.</i></p>	

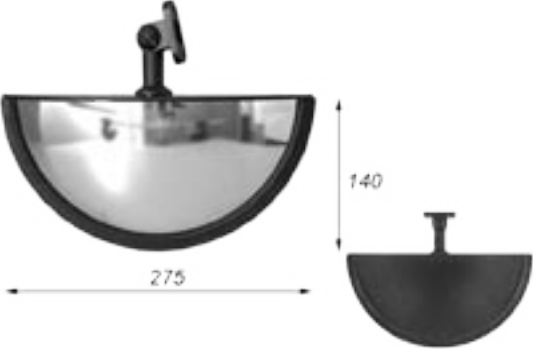
# SPECCHI RETROVISORI REAR-VIEW MIRRORS

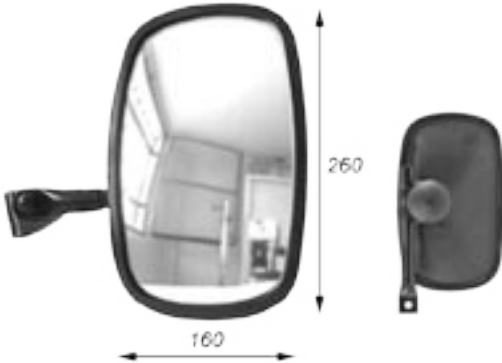
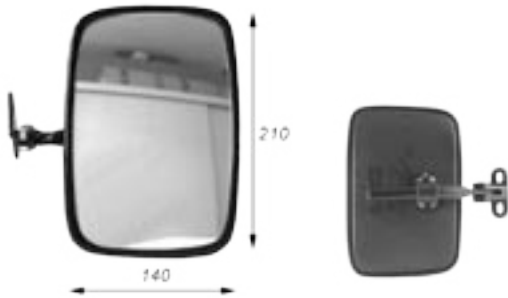
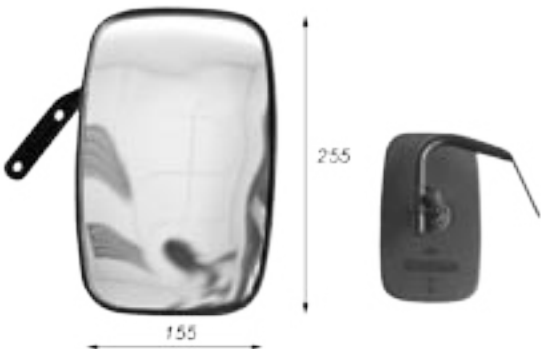

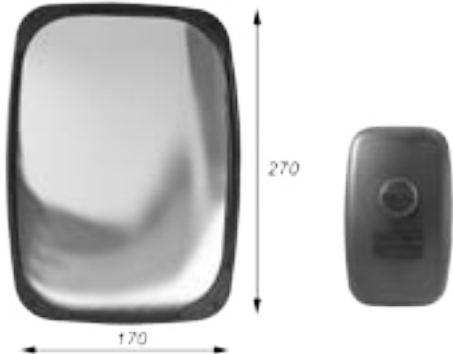
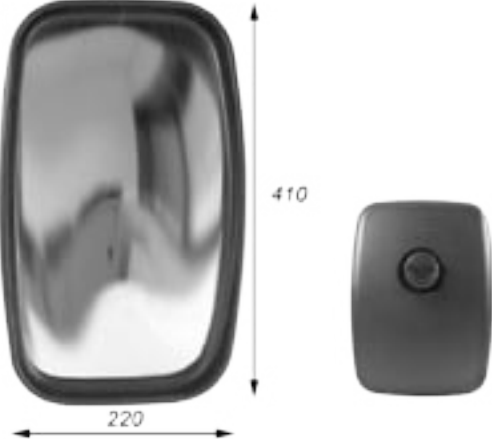
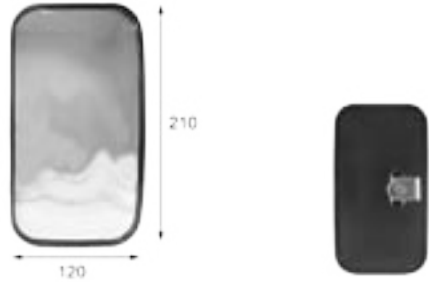
<p><b>9216B</b></p>	<p>Specchio retrovisore convesso regolabile, a visione panoramica di 180°, antiurto, staffa rinforzata. <i>Convex rear mirror, adjustable, with wide angle view (180°), shock resistant, reinforced bracket.</i></p> <p style="text-align: center;">Adatt. / Applic.: CESAB TOYOTA</p>	 <p>Technical drawing of a convex rear-view mirror. The front view shows a semi-circular mirror with a diameter of 275 mm. The side view shows a height of 140 mm. A second view shows the mirror with its mounting bracket.</p>
<p><b>9216E</b></p>	<p>Specchio retrovisore convesso regolabile, a visione panoramica di 180°, antiurto, staffa in metallo. <i>Convex rear mirror, adjustable, with wide angle view (180°), shock resistant, metal bracket.</i></p>	 <p>Technical drawing of a convex rear-view mirror. The front view shows a semi-circular mirror with a diameter of 245 mm. The side view shows a height of 130 mm. A second view shows the mirror with its metal mounting bracket.</p>
<p><b>9216C</b></p>	<p>Specchio retrovisore convesso, regolabile. <i>Convex rear-view mirror, adjustable.</i></p>	 <p>Technical drawing of a rectangular convex rear-view mirror. The front view shows a height of 260 mm and a width of 160 mm. A second view shows the mirror with its mounting bracket.</p>
<p><b>9216D</b></p>	<p>Specchio retrovisore piatto, regolabile. <i>Flat rear-view mirror, adjustable.</i></p> <p>OMOLOGATO per uso stradale. <i>HOMOLOGATED for road use.</i></p>	 <p>Technical drawing of a rectangular flat rear-view mirror. The front view shows a height of 210 mm and a width of 140 mm. A second view shows the mirror with its mounting bracket.</p>
<p><b>9216F</b></p>	<p>Specchio retrovisore piatto, regolabile. <i>Flat rear-view mirror, adjustable.</i></p> <p>OMOLOGATO per uso stradale. <i>HOMOLOGATED for road use.</i></p>	 <p>Technical drawing of a rectangular flat rear-view mirror. The front view shows a height of 255 mm and a width of 155 mm. A second view shows the mirror with its mounting bracket.</p>

<p><b>9216G</b></p>	<p>Specchio retrovisore piatto, regolabile. <i>Flat rear-view mirror, adjustable.</i></p> <p>OMOLOGATO per uso stradale. <i>HOMOLOGATED for road use.</i></p>	 <p>Technical drawing of a flat rear-view mirror. The main view shows a rounded rectangular mirror with a width of 170 and a height of 270. A secondary view shows the back of the mirror housing.</p>
<p><b>9216H</b></p>	<p>Specchio retrovisore grande, piatto, regolabile. <i>Flat big rear-view mirror, adjustable.</i></p> <p>OMOLOGATO per uso stradale. <i>HOMOLOGATED for road use.</i></p>	 <p>Technical drawing of a large flat rear-view mirror. The main view shows a rounded rectangular mirror with a width of 220 and a height of 410. A secondary view shows the back of the mirror housing.</p>
<p><b>9216T</b></p>	<p>Specchio retrovisore convesso. <i>Convex rear-view mirror.</i></p> <p>Adatt. / Applic.: TOYOTA</p>	 <p>Technical drawing of a convex rear-view mirror. The main view shows a rounded rectangular mirror with a width of 120 and a height of 210. A secondary view shows the back of the mirror housing.</p>

## TRANSPALLET MANUALI MANUAL TRANSPALLET

	<p>Transpallet manuali con pompa in ghisa rinforzata. <i>Manual transpallet with reinforced cast iron pump.</i></p> <p>Portata / <i>Load capacity:</i> 2500 kg max Alzata / <i>Lift:</i> 85 mm Forche / <i>Forks:</i> 1150 x 540</p>	
9393A	A rullo singolo / <i>With single roller.</i>	
9393B	A rullo doppio / <i>With twin roller.</i>	

## PEDANA BLOCCAGGIO TRANSPALLET TRANSPALLET STOPPER



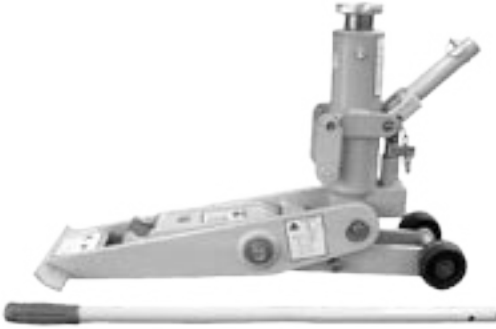

9394	<p>Pedana per il bloccaggio dei transpallet, in materiale plastico antiurto. Base gommata per evitare spostamenti indesiderati su mezzi in movimento. <i>Transpallet stopper, made of reinforced plastic. Rubber base to avoid unwanted movements on travelling vehicles.</i></p>	
		

## SOLLEVATORI JACKS

9391T	<p>Sollevatore idraulico, portata 40 q.li, alzata 400 mm. <i>Hydraulic jack, load capacity 4 tons, lift 400 mm.</i></p>	
-------	---	--

<b>9392T</b>	Coppia supporti h. 240-395 mm, portata 130 q.li. <i>Set of two supports, h. 240-395 mm, load capacity 13 tons.</i>	
--------------	---	--

## TERGICRISTALLO WINDSHIELD WIPERS

<b>28100</b>	Motore 12V tergicristallo corsa 85°, albero conico Ø8 mm. <i>Windshield wiper motor, 12V, 85° run, conical shaft Ø8 mm.</i>	
<b>28101</b>	Motore 12V tergicristallo corsa 105°. <i>Windshield wiper motor, 12V, 105° run.</i>	
<b>28102</b>	Braccio regolabile mm 425-505, per albero Ø8. <i>Wiper arm, adjustable 425-505 mm, for shaft Ø8.</i>	
<b>28103</b>	Spazzola 410 mm. <i>Wiper 410 mm.</i>	
<b>28104</b>	Spazzola 450 mm. <i>Wiper 450 mm.</i>	

# INGRASSATORI GREASE NIPPLES

**35200**

Cassetta di assortimento ingrassatori UNI 7663 .  
*Grease nipple assortment box UNI 7663.*  
70 pezzi / 70 pieces

Diritti / *Straight*

M6x1 10 pz / pcs  
M8x1 10 pz / pcs  
M10x1 10 pz / pcs  
R 1/8" 10 pz / pcs

45°

M6x1 5 pz / pcs  
M8x1 5 pz / pcs  
M10x1 5 pz / pcs

90°

M6x1 5 pz / pcs  
M8x1 5 pz / pcs  
M10x1 5 pz / pcs



**35000**  
**35000C**

M6x1  
» » Conf./Pack.:100 pz/pcs

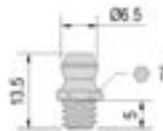

**35001**  
**35001C**

M8x1  
» » Conf./Pack.:100 pz/pcs

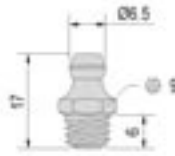

**35002**  
**35002C**

M8x1,25  
» » Conf./Pack.:100 pz/pcs



**35003**  
**35003C**

M10x1  
» » Conf./Pack.:100 pz/pcs

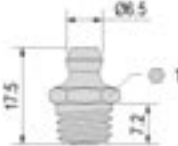

**35004**  
**35004C**

M10x1,5  
» » Conf./Pack.:100 pz/pcs



**35005**  
**35005C**

R 1/8"  
» » Conf./Pack.:100 pz/pcs





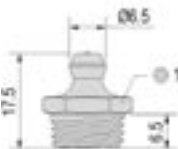

**35006**  
**35006C**





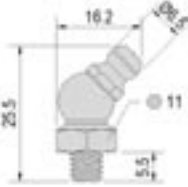

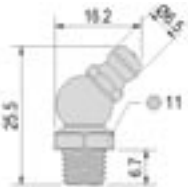
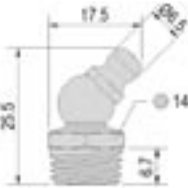
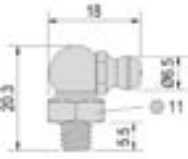
R 1/4"  
» » Conf./Pack.:100 pz/pcs

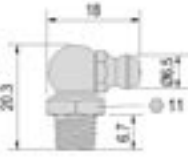
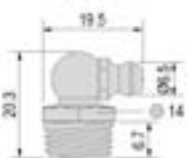

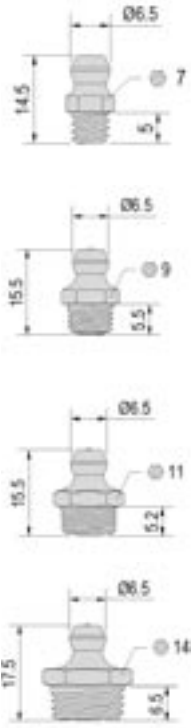

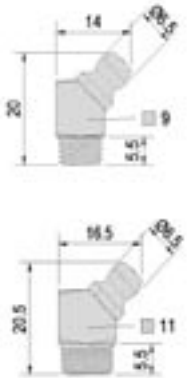
12

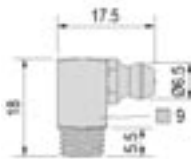

		<p>Ingrassatori a 45° UNI 7663-B. Grease nipples 45° version to UNI 7663-B.</p>		
<p><b>35007</b> <b>35007C</b></p>	<p>M6x1 » » Conf./Pack.:100 pz/pcs</p>			
	<p><b>35008</b> <b>35008C</b></p>	<p>M8x1 » » Conf./Pack.:100 pz/pcs</p>		
	<p><b>35009</b> <b>35009C</b></p>	<p>M8x1,25 » » Conf./Pack.:100 pz/pcs</p>		
	<p><b>35010</b> <b>35010C</b></p>	<p>M10x1 » » Conf./Pack.:100 pz/pcs</p>		
	<p><b>35011</b> <b>35011C</b></p>	<p>R 1/8" » » Conf./Pack.:100 pz/pcs</p>		
<p><b>35012</b> <b>35012L</b></p>	<p>R 1/4" » » Conf./Pack.:50 pz/pcs</p>			
		<p>Ingrassatori a 90° UNI 7663-C. Grease nipples 90° version to UNI 7663-C.</p>		
<p><b>35013</b> <b>35013C</b></p>	<p>M6x1 » » Conf./Pack.:100 pz/pcs</p>			
	<p><b>35014</b> <b>35014C</b></p>	<p>M8x1 » » Conf./Pack.:100 pz/pcs</p>		
	<p><b>35015</b> <b>35015C</b></p>	<p>M8x1,25 » » Conf./Pack.:100 pz/pcs</p>		
	<p><b>35016</b> <b>35016C</b></p>	<p>M10x1 » » Conf./Pack.:100 pz/pcs</p>		
	<p><b>35017</b> <b>35017C</b></p>	<p>R 1/8" » » Conf./Pack.:100 pz/pcs</p>		
	<p><b>35018</b> <b>35018L</b></p>	<p>R 1/4" » » Conf./Pack.:50 pz/pcs</p>		

<p><b>35100</b></p> <p><b>35101</b></p> <p><b>35102</b></p> <p><b>35006</b></p>	<p>Ingrassatori dritti DIN 71412-A. Grease nipples straight version to DIN 71412-A.</p>  <p>M6x1</p> <p>M8x1</p> <p>M10x1</p> <p>R 1/4"</p>	
<p><b>35103</b></p> <p><b>35104</b></p> <p><b>35105</b></p>	<p>Ingrassatori a 45° DIN 71412-B. Grease nipples 45° version to DIN 71412-B.</p>  <p>M6x1</p> <p>M8x1</p> <p>M10x1</p>	
<p><b>35106</b></p> <p><b>35107</b></p>	<p>Ingrassatori a 90° DIN 71412-C. Grease nipples 90° version to DIN 71412-C.</p>  <p>M6x1</p> <p>M8x1</p>	

## STRUMENTI PER INGRASSAGGIO GREASING TOOLS

<b>35204K</b>	Kit di ingrassaggio professionale a leva per cartucce Ø 52 mm. <i>Professional greasing kit for Ø 52 mm cartridges.</i>	
<b>35203</b>	Cartuccia di grasso al litio, NLGI 2, Ø 52 mm, 400 g. <i>Lithium grease cartridge, NLGI 2, Ø 52 mm, 400 g.</i>	
<b>35202</b>	Testina idraulica a 4 griffe professionale, M10. <i>Professional hydraulic coupler with 4 jaws, M10.</i>	

**Su richiesta sono fornibili altre tipologie di ingrassatori e di attrezzi specifici.**

***Upon request we can supply other types of grease nipples and tools.***

## SPAZZOLE CARRELLI PER PULIZIA PIAZZALI CLEANING BRUSHES FOR FORKLIFTS



Spazzole industriali con innesto su forche, per la pulizia di piazzali.

Dimensioni standard fornibili (L x P x H=400 mm):

950x500; 1400x500; 1400x700; 1900x500; 1900x700; 1900x1000; 2400x700; 2400x1000; 2900x700 mm

Setole in acciaio o polipropilene.

Accessori fornibili: lame di spinta, sponde laterali, kit abbattimento polvere ad acqua, attacco per pinze, attacco per trattori.

Chiamateci per informazioni.

*Industrial brushes with fork mount for cleaning wide floors.*

*Standard dimensions (W x L x H=400 mm):*

*950x500; 1400x500; 1400x700; 1900x500; 1900x700; 1900x1000; 2400x700; 2400x1000; 2900x700 mm*

*Steel or polypropylene bristles.*

*Options: pushing front blades, side walls, dust suppression by water, hooks for pinchers, hooks for tractors.*

*Call us for information.*

